

SALICE PAOLO

# NEWS 2015

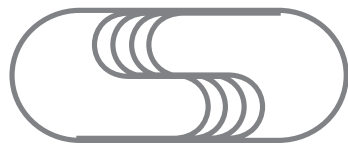



SALICE PAOLO



# REFLEX



# REFLEX

Davide Diliberto e Manuela Bucci



Espressione dei trend più attuali in cui coesistono un aspetto morbido e un design regolare, valorizzati dagli spessori sottili. Ideale per ambienti moderni e il contract.

*An expression of the latest trends in which a soft appearance coexists with a regular design, enhanced by its thin outline. Perfect for modern locations as well as contract projects.*



**6155**

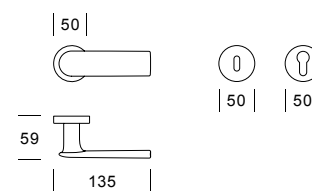

### Finiture Finishes

CR    Cromo  
      Chrome

CRS   Cromo satinato  
       Satin chrome

GR    Grafite  
       Graphite



# REFLEX



6158

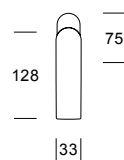

6157

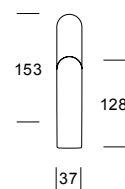

6156

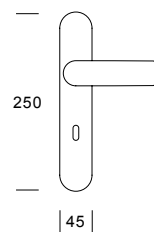

# REFLEX

CR



CRS



GR





# LIFE



# LIFE

Davide Diliberto e Manuela Bucci



L'essenza del design ergonomico, dove il metallo liquido prende vita, assecondando le forme della mano. Decora con i chiaroscuri decisi e contrapposti, in continuo movimento.

*The essence of ergonomic design, where the liquid metal comes to life supporting the hand shapes. Enhance with definite and contrasted "chiaroscuro", in a never-ending motion.*



**6160**

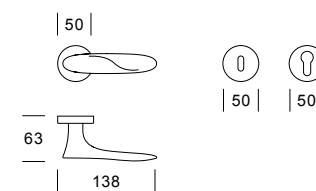

### Finiture Finishes

CR

Cromo  
Chrome

CRS

Cromo satinato  
Satin chrome

GR

Grafite  
Graphite





6163

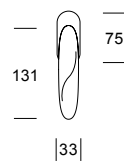

6162

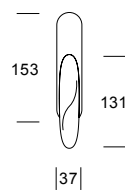

6161

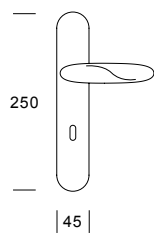

CR



CRS



GR



# WOOD



# WOOD

Davide Diliberto e Manuela Bucci



Nasce per risolvere esigenze di abbinamento con pavimenti, soffitti, travi a vista e mobilio in cui il legno è protagonista. Moderna, ironica e camaleontica, si adatta ad ambienti minimalisti, industrial e persino country.

*Born to solve the need of matching floors, ceilings, oak-beamed and furniture where wood is the only protagonist. Modern, ironic and chameleon adapts to minimalist, industrial and even country settings.*



6165

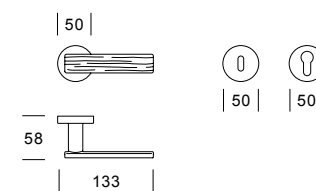

## Finiture Finishes

CR

Cromo  
Chrome

CRS

Cromo satinato  
Satin chrome

GR

Grafite  
Graphite



# WOOD



6168

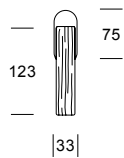

6167

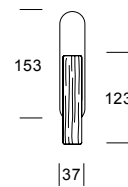

6166

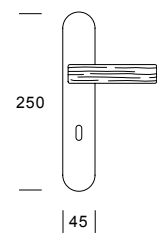

# WOOD

CR



CRS



GR





## C3 rosetta / rose



## C3 rosetta / rose

Studio Salice Paolo



La rosetta più piccola sul mercato: 33 mm di diametro, 3 mm di spessore grazie ai componenti inseriti nella porta. Un design extra flat che valorizza al massimo ogni maniglia.

*The smallest rose on the market: 33 mm diameter, 3 mm thick thanks to the components inserted in the door. An extra flat design that makes the most of each handle.*

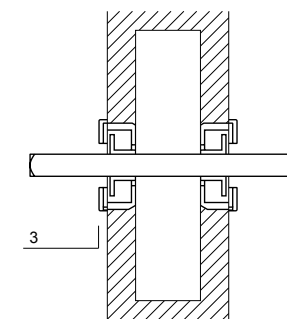

**Innovazione tecnica Salice Paolo**  
**Salice Paolo's technical innovation**



# REFLEX C3



6155C3

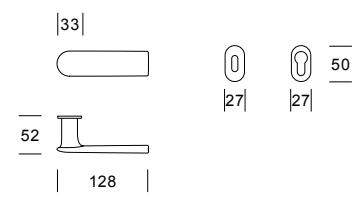

CRS



GR



# LIFE C3



6160C3

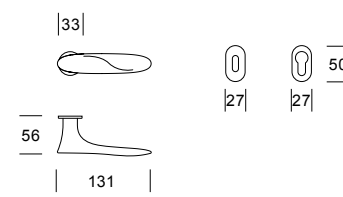

CRS



GR





# WOOD C3



6165C3

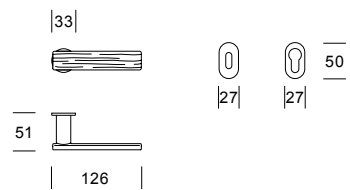

CRS



GR



## FINITURE FINISHES

CR



Cromo  
 Chrome  
 Chromé  
 Cromato  
 Хром

CRS



Cromo satinato  
 Satin chrome  
 Chromé satin  
 Cromato satinado  
 Сатинированный хром

GR



grafite  
 graphite  
 graphite  
 grafito  
 Графит

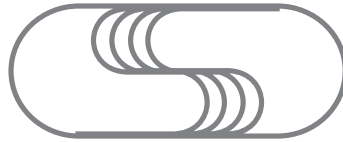

SALICE PAOLO

SALICE PAOLO srl  
Via Domea, 45  
22063 Cantù (CO) Italy  
P.O. Box 119  
T +39 031 714520  
F +39 031 706177  
[info@salicepaolo.it](mailto:info@salicepaolo.it)  
[www.salicepaolo.it](http://www.salicepaolo.it)